



Putzmeister



Delivery line systems

Safely from A to B

Whatever result you want to bring about ...

Power and pipeline – A first-class combination

Over the years and decades, our concrete pumps have become increasingly more powerful. This is an achievement that makes us proud, and which ultimately serves to achieve your objectives faster and more effectively.

There are high demands which you can place on our pumps and which should be just as decisive when selecting the delivery lines. This applies as much for the pipework in the boom as it does for stationary delivery lines.

With the SK and ZX series, or the PX hose system, we are offering, in combination with the relevant pump, an optimum system for the economical and safe conveying of concrete and mortar.



Flying high – The pipework in the boom

Delivery lines need to meet many diverse demands resulting from their particular use, the medium to be conveyed and the connected pump. For example, the pipework on the placing boom of truck-mounted concrete pumps is required to be flexible and movable. However, the components must be extremely robust and must have a long service life in order to keep the operating costs low and to maintain the level of availability of the machine.

Suitable for handling long distances – Stationary delivery lines

The task of stationary delivery lines is to transport the widest range of concrete to wherever it is poured or further processed. When combined with stationary concrete pumps, it is high pressure that the lines must withstand. At the same time, they should also be wear-resistant and it must be possible to adapt them to all conditions of use with an extensive range of accessories.



Promising – Solutions with a system

Concrete must be frequently transported over longer distances reliably, quickly and safely. This is not always easy. In most cases this involves overcoming a number of obstacles, particularly if the destination is very ambitious or far away, with restrictions to be overcome or circumvented. This then requires complete solutions that are practical and economical. Our engineers are happy to provide you with advice about the process-oriented composition of the individual components, such as a powerful pump, delivery line and appropriate accessories.



Congestion-free feeder for all demands

Outstanding properties in all parts

Increasingly more pressure, increasingly more output – the further development of the pumps has also had a decisive influence on the properties of delivery lines. They must remain leak-proof at extremely high pressures and withstand higher flow rates over as long a time period as possible. However, the greater the volumetric flow rate, the higher the level of stress and wear. The delivery line systems from Putzmeister

therefore have various resources to counter this. Extremely robust pipes, for example, are available which have various levels of wear behaviour depending on the use and medium. For the highest demands, these are reinforced at the coupling connections. Bends which, by nature, are particularly susceptible to wear are made of extremely durable manganese cast iron, and they also have thicker pipe walls if they are used for

stationary concrete conveying processes. When it comes to hoses, the inner wall has been stripped out in order to achieve a seamless transition between the connections. This not only has a positive effect on the wear properties, but it also prevents blockages from forming. These are just a few of the many sensible developments that are based on years of practical experience.



A system is only perfect when it is complete

Delivery lines with matching coupling systems create a connection that is one hundred percent secure. They are adjusted to the purpose and, depending on this, are extremely mobile, easy to assemble, quick to open or extremely rigid. Reducers, transition pieces, delivery and end hoses, a wide range of cleaning accessories and measuring instruments are available to provide an integrated system solution. Our systems provide you with the best manually and hydraulically operated gate valves and transfer tubes, which can be operated via external hydraulic power packs or, where possible, directly via the stationary concrete pump.



Overview of the applications of delivery line systems

	Construction	Tunnelling and mining	Industry
SK system	Truck-mounted concrete pump Shorter stationary line	Injection work Concrete spraying	Prefabricated parts plants
ZX Zentrifix® system	Stationary concrete pump High and long-distance delivery	Concrete transport Long-distance delivery De-watering of mines Backfilling	Sewage treatment plant, nuclear power plant, waste recycling, water sludge removal and others
PX Ultraflex® system	Extension lines Renovation work Concrete truck mixer pump	Concrete spraying Injection work	Prefabricated parts plants



SK standard coupling system
(see page 6–9)

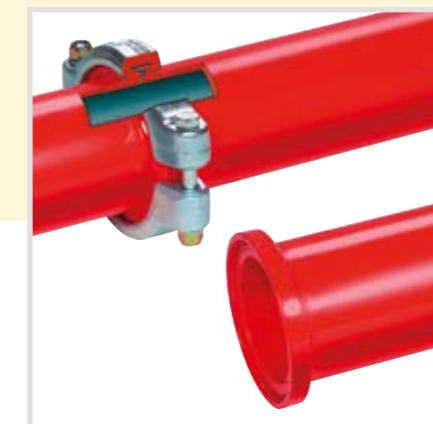

ZX delivery line system
(see page 10–11)



PX hose system
(see page 12–13)

The SK delivery line system – The ideal combination of robustness and adaptability

SK system – Absolutely robust, no matter how you twist and turn it

The SK quick-release coupling system is ideal if pipelines must be installed flexibly and quickly, and concrete pressures are up to 85 bar*. They can also be rotated axially and can be bent by up to 2° so that they can be optimally adapted to the conditions at the construction site. Due to these preferences, the SK system comes as standard equipment on Putzmeister truck-mounted concrete pumps, but is also very well suited for shorter, fixed pumping distances on uneven terrain.

* When using special seals (Trilip), this may be up to 130 bar.



SK two-layer pipes

When it comes to costs per m³ of pumped medium, it may be more economical for highly abrasive materials and high outputs to invest more in the delivery line. For a longer life, Putzmeister therefore offers two-layer pipes. These consist of a hardened, especially wear-resistant inner pipe and a soft outer cladding and protective pipe.

Standard two-layer pipe:

This pipe has an internal hardness of 63 HRC Rockwell (corresponding to approx. 780 Vickers). For delivery lines on the placing boom, the inner pipe is 2 mm (PM 22) or 2.5 mm (PM 252) thick, while the outer pipe is 2 mm thick.

PROLINE two-layer pipe:

These pipes have been proved to last for twice as long as standard two-layer pipes for the same concrete grade/abrasiveness class, and they achieve a service life which is ten times longer than that of pipes made from ST 52. This is because they have an extremely high level of hardness (up to 67 HRC). Points in the line which are particularly susceptible to wear are also reinforced using special cast parts – PROCAST rings. This minimises the expenditure that is required for modifying and maintaining the line.

Elbows for two-layer pipes

Elbows and reducers and other pipeline parts made from the same hardened or two-layer materials are available to suit all quality levels of the two-layer pipes. With these, we can offer you special PROLINE-quality elbows whose properties are adapted precisely to the application at hand. For example, the impact and turret elbows are manufactured in PROCAST material (special cast iron). PROLINE elbows are distinguished by a pressure-resistant steel frame and a wear-resistant cast-in insert which is reinforced at particularly critical points.

SK delivery pipes – in two versions

With our delivery pipes, you have the choice between two variants with two different levels of quality: The single-layer pipes, which are the inexpensive variant for normal abrasive media, and the two-layer pipes, which provide particular durability for materials which are liable to cause wear.

SK single-layer pipes

Single-layer SK delivery pipes are particularly economical for standard, mildly abrasive concrete compositions and moderate concrete pressures up to 85 bar, or in the reinforced special model with Trilip sealing inserts, up to 130 bar. Pipes are available that have a nominal internal diameter of 50 to 150 mm. These delivery pipes are manufactured in ST 52.0 steel with factory certificate 3.1 B in accordance with DIN 2448/DIN EN 10220.

Elbows for SK lines (single-layer)

Manganese cast iron elbows:

Elbows for boom pipework, which are especially wear-resistant.

Large radius elbows:

Pipe elbow type for stationary concrete pumps, with thicker walls – also for higher pressures.



Overview of the SK delivery line system

SK delivery line system – ST 52

ST 52 plus 85 bar

Designation/nominal internal diameter	Product sheet
SK 50 - 3	BP 2480
SK 65 - 3	BP 2481
SK 100 - 4	BP 2482
SK 100 - 4,5	BP 2483
SK 120 - 5	BP 2484
SK 125 - 5,5	BP 2485
SK 150 - 6	BP 2486

Reinforced ST 52 plus 85 bar/130 bar

Designation/nominal internal diameter	Product sheet
SK 125 - 5,5 HD 130 bar	BP 2515
SK 150 - 6 HD 130 bar	BP 2516

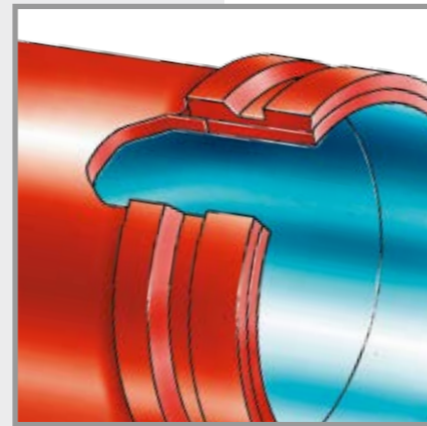

SK delivery line system – Two-layer pipe

Two-layer delivery line 85 bar/63 HRC

Designation/nominal internal diameter	Product sheet
SK 100 PM 22	BP 2509
SK 125 PM 252	BP 2504
SK 125 PM 22	BP 2506
SK 125 PM 53	BP 2508

PROLINE two-layer delivery line 85 bar/67 HRC

Designation/nominal internal diameter	Product sheet
SK 125 PM 252P 67 HRC	BP 3484
SK 125 PM 22 P 67 HRC	BP 3485
SK 125 PM 53 P 67 HRC	BP 3486
SK 112 PM 2020 P 67 HRC	
SK 117 PM 2015 P 67 HRC	

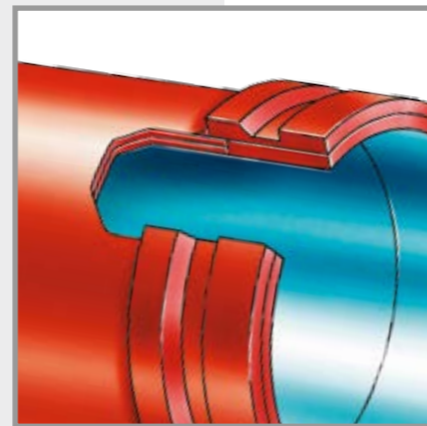

SK-H lever coupling

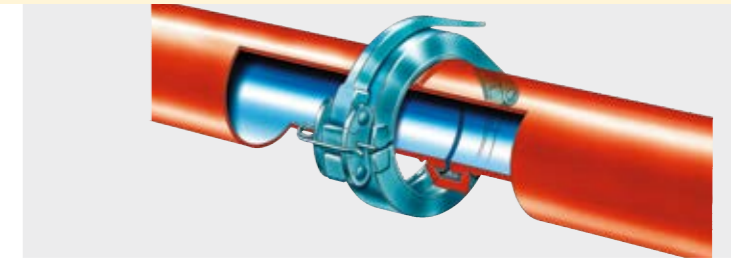

SK-H lever coupling as mounting coupling

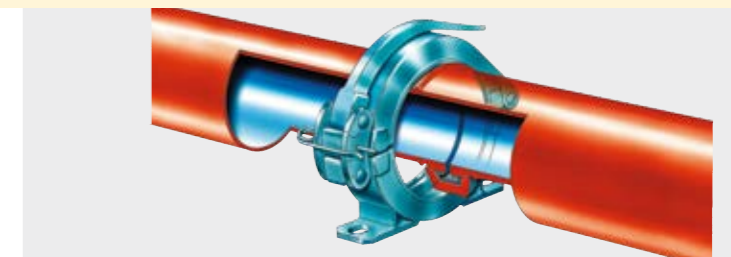

SK-S threaded coupling

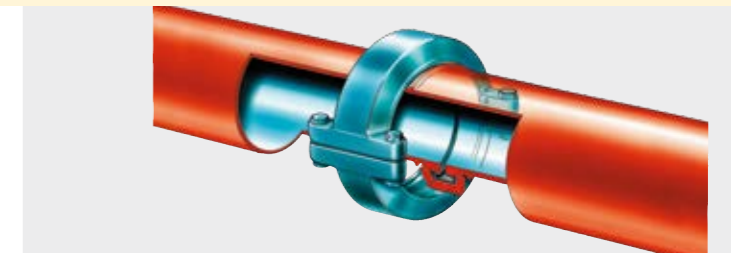

SK-K handle coupling

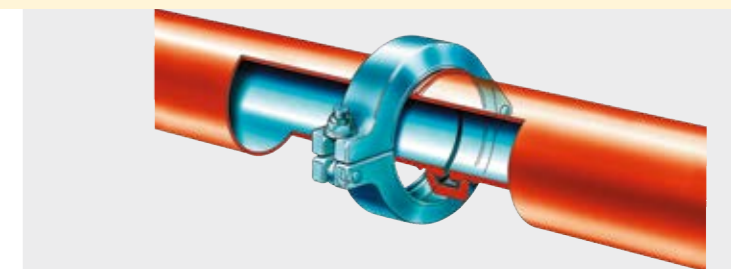

Couplings

All SK couplings from Putzmeister are drop-forged and are electrogalvanized as standard, this guarantees a long life and reliable use. A securing cotter pin on the lever couplings prevents the coupling from being opened unintentionally when under pressure. You can choose between three different models:

- SK-H lever coupling as a flexibly mounted coupling or as a mounting coupling; for extremely fast, uncomplicated manual opening without the need for additional tools
- SK-S threaded coupling as a secured connection for delivery lines
- SK-K handle coupling for the fast assembly of delivery lines which should be secured and are not opened frequently

ZX Zentrifix® – Robust connection which is absolutely leak-proof

ZX Zentrifix® system – Extremely resilient at high pressures and with heavy materials

Pumping under high pressure – this is where particularly high demands are placed on the delivery line. They must be absolutely leak-proof, stable and wear-resistant. The ZX delivery line system from Putzmeister fulfils these criteria with ease, and is therefore ideal for fixed, stationary pipe systems in concrete high-rise and long-distance placement. However, beyond construction sites, the system is tried and tested in a wide variety of industrial applications, not least due to it being absolutely leak-proof which is created thanks to the connection between male (ZXV) and female (ZXM) flanges. In this case, the O-ring inserted in a groove acts as a press-in seal which is pressed firmly in its place during assembly. In this way, the ZX system is particularly suitable for highly liquid materials and pulsating pressures. In addition to the high pressure resistance, the wall thicknesses, which are up to 11 mm, also provide a long wear lifetime.



ZX delivery line system

ZX delivery lines Low pressure 85 bar

Designation/nominal internal diameter	Product sheet
ZX 125 ND	BP 2488
ZX 140 ND	BP 2487

ZX delivery lines for industrial applications

Designation/nominal internal diameter	Product sheet
ZX 125 95 bar	IP 2510
ZX 150 100 bar	IP 2511
ZX 200 70 bar	IP 2512
ZX 250 85 bar	IP 2513

ZX delivery lines High pressure 130 bar

Designation/nominal internal diameter	Product sheet
ZX 80 HD	BP 2490
ZX 100 HD	BP 2491
ZX 125 HD	BP 2492
ZX 140 HD	BP 2495
ZX 150 HD	BP 2496
ZX 200 HD	BP 2497

ZX delivery lines Super high pressure

Designation/nominal internal diameter	Product sheet
ZX 125 200 bar	BP 2493
ZX 120 250 bar	—
ZX 125 250 bar	—

Note: Other dimensions are available on request

ZX delivery pipes

Through static calculations and material testing, ZX concrete delivery pipes are designed for the specific required pressures in the concrete.

Elbows for ZX lines

- Small-radius elbows with radii of 280–400 mm
- Large-radius elbows with a radius of 1000 mm

Elbows and reducers and other pipeline parts made from the same hardened materials are available to suit all delivery line systems, as is the case for pipes.

Couplings

All Putzmeister Zentrifix® couplings are drop-forged and are electrogalvanized as standard. You can choose between three different types of coupling:

- ZX-S threaded couplings: Absolutely leak-proof; assembly of delivery lines that have to be rerouted only rarely or never
- ZX-K handle couplings for quick assembly of delivery lines for which the routing is changed
- ZX-W key clutches for delivery lines which have to be opened at lightning speeds (e.g. on stationary concrete pumps in the area of the hopper, or after each concreting as part of cleaning the line)

ZX-S threaded coupling

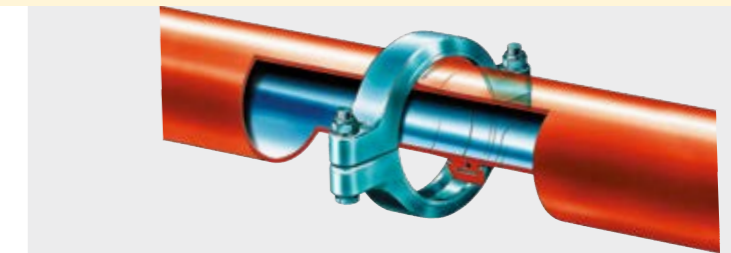

ZX-K handle coupling

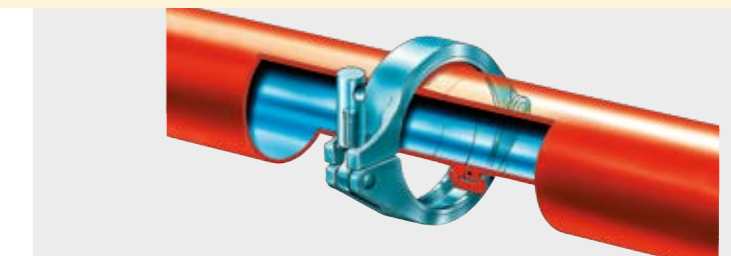

ZX-W wedge fitting

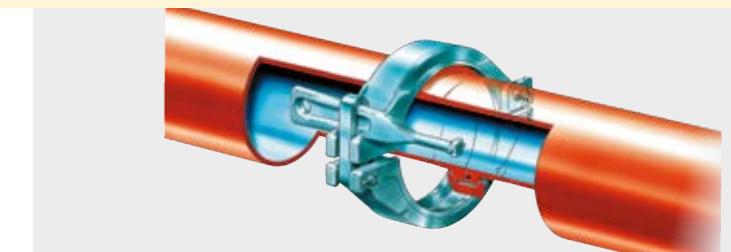

PX Ultraflex® – For jobs with lots of corners

PX Ultraflex® system – Child’s play to install

It does what it’s supposed to do. The PX Ultraflex® delivery line system from Putzmeister is distinguished by its high level of flexibility. Always flexible, whether in its possible applications, handling or when it comes to its ability to adapt to its surroundings. When used in construction as an extension line, with the Saniermobil or with our truck mixer concrete pumps (PUMI®), during concrete spraying or injection work – the PX hose system is easy to assemble and to dismantle with connections being quick and easy to establish by one person. The coupling connection is centred thanks to the male/female system, and the connection is rigid, yet it can still be axially rotated when the delivery pressure is low. The O-ring ensures that the line remains absolutely leak-proof and that the transition is then free from wear. When it comes to the wear characteristics, the PX Ultraflex® system is up there with the steel delivery lines (SK) and guarantees a long service life.



Due to this design, the system is not only ideal for pumping concrete, but also for conveying mortar and screed mixtures, and the PX line is also particularly easy to maintain and clean as the seal no longer needs to be removed and scraped out separately. Due to these properties PX Ultraflex® is mainly used for hoses which have to be assembled quickly and frequently, and which then have to be disassembled again.

Simpler handling with the Hose Caddy

The Hose Caddy is the convenient hose carriage from Putzmeister. It is manufactured from polyurethane and is therefore only half the weight of conventional steel carriages, and is suitable for all available delivery hoses. In addition to its designed purpose, the Hose Caddy also has a further safety benefit of preventing any unintended opening of the coupling due to a forgotten safety clip or by being caught in the steel reinforcement.

Delivery hoses

Delivery hoses are subject to a continuously high load, so the tested quality and durability of the hose material are vitally important, which is why we have used a particularly abrasion-resistant natural rubber for the hose construction. In addition, PX hoses from Putzmeister have an inserted carcass that is made from robust steel wire which has been woven four times, in a similar process as for a steel belt tyre. The steel ends of the hoses are also hardened to over 60 HRC to make these exceptionally wear-resistant. Conventional hose lines frequently have a burr or an edge on the internal transition between the hose and the end piece, which is where blockages may easily form. In contrast, the inner walls of delivery hoses from Putzmeister are stripped out so that they have a seamless transition between the connections, which drastically reduces both wear and the risk of blockage.

Couplings

SK standard couplings are used for the PX system. These are drop-forged and electrogalvanized as standard to guarantee a long life and reliable use. Furthermore, a securing cotter pin prevents the coupling from being opened unintentionally when under pressure.

You can choose between three different models:

- SK-H lever coupling as a flexibly mounted coupling or as a mounting coupling; for extremely fast, uncomplicated manual opening without the need for additional tools
- SK-S threaded coupling as a secured connection for delivery lines
- SK-K handle coupling for the fast assembly of delivery lines which are opened frequently

PX Ultraflex® delivery line system

Hose delivery lines

Designation/nominal internal diameter	Product sheet
PX 65	BP 2501
PX 75	BP 2502

PX coupling with pipeline



PX coupling with hose line

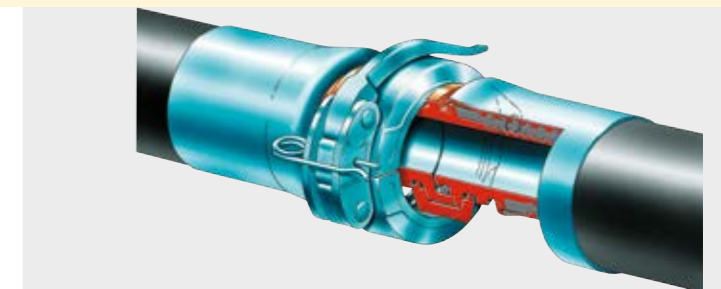

For today and beyond

Transfer tubes and gate valves regulate the material flow

Gate valves and transfer tubes ensure that everything is in order: They determine where the material goes and when it is allowed to flow, and the most important property of a gate valve or a transfer tube is being leak-proof and having maximum operational availability.

From decades of experience with extreme applications, these components have been continuously developed by Putzmeister and enhanced in such a way that they meet the highest demands placed on a modern pipework system. Whether it is a simple gate valve or more complicated transfer tube system, you can rely on the fact that nothing will leak out. In high-pressure versions, spectacle wear plates and metal rings perform the task of sealing. In this way, operating pressures of up to 250 bar can be achieved in a controlled system.



Manual and hydraulic gate valves

GVM manual gate valve

GVM manual gate valves are operated manually by shutting off the delivery line independently of an external power supply. The gate valve sheet is closed across the delivery line using a hammer, and is opened again in the same way. These are available both for low pressure requirements up to 20 bar (gate valves for formwork) and for high-pressure applications up to 200 bar.

GVHM manual gate valve

In this light gate valve model, the valve is also opened and closed manually, but the process is supported hydraulically. This makes operating the valve easier, but it can still be done independently of an external power supply if required. This gate valve is used for pressures up to 130 bar.

GVH hydraulic gate valve GVH

GVH hydraulic gate valves are operated hydraulically, are pressure-resistant and are available in various versions up to 250 bar. The hydraulic supply is provided either by a stationary concrete pump or an external hydraulic power pack. GVH hydraulic gate valves can also be fitted with limit switches so that the gate valve can be easily electrically actuated, and a signal is fed back to the remote control telling it whether the gate valve is open or closed.



Transfer tubes for two or more delivery lines

DVH hydraulic transfer tubes

This system makes it possible to quickly switch to a second line. For example, this means that you can, as required, switch over to a bypass line or a wash-out adaptor for convenient cleaning of the delivery line. The washing out process can also be introduced in line A at the same time as concrete is pumped into line B.

SDVH hydraulic transfer tubes

The S transfer tube is ideal for uses with concrete pressures up to 130 bar. The S transfer tube enables the repeated, parallel loading of two lines, as well as the shut-off of a delivery line. The fast switching required to achieve this is driven hydraulically via an external power supply, either via the stationary concrete pump or a hydraulic power pack. In comparison to conventional products, this also permits applications in the high-pressure range.

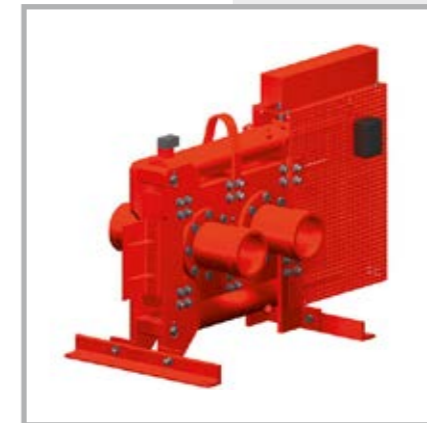

Pressure brings movement into play

External hydraulic power packs

If the hydraulics of gate valves and transfer tubes cannot be operated via the agitator hydraulic circuit of the BSA concrete pumps, external hydraulic power packs from Putzmeister produce the required fluid pressure in order to operate these. With a fluid pressure of 150 to 315 bar, they even master high loads. In this case, different variants and practical accessories are available for an extremely wide range of applications and demands.

Drive alternatives

Hydraulic power packs with hand pump

Hydraulic power packs that are operated using a hand pump are, on the one hand, the most cost-effective variant of all the power packs and, on the other, thanks to their independence from an external power supply, can be operated in any location and reliably in any situation.

Hydraulic power packs with electric drive

Hydraulic power packs from Putzmeister can be fitted with an electric drive and manual control valves, and if required, also with electric valves. With the last option, an electric control cabinet is required, to which a remote control* can be connected. Hydraulic power packs with various outputs are available.

Hydraulic connection via the concrete pump

The gate valve can also be connected to the agitator hydraulic circuit of a concrete pump. This is usually protected with 220 bar. Further options can be individually defined depending on the concrete pump.

* Remote control

Transfer tubes and gate valves can be actuated via remote control. This remote control has "Open" and "Closed" switch positions, a limit switch and signal lamps, which display the position of the gate valve. We can also offer other versions on request.



Technical data of the hydraulic power packs

With electric drive		With hand pump	
Power	7.5 kW	Max. pressure	300 bar
Max. pressure	315 bar	Manual force at 300 bar	Approx. 320 N
Pumping volume	12 l/min	Pumping volume	29 cm ³ per double stroke
Tank content	63 l		
Useful capacity	40 l		

* Optionally with or without remote control.

Coupling expressly required

Reducers and transition pieces* close gaps in the line

Putzmeister supports your concrete conveying process with systems that are optimally integrated with each other. From the pump through the line and to the distribution – with the complete solutions from Putzmeister you not only work effectively but also economically. A wide range of accessories and functional components are required for this, and these are available from Putzmeister with the level of quality that one would expect from such a supplier.

Pipeline mounting

If the material is flowing at high pressure, forces come into play which make the lines start to move. In the worst case scenario, this may lead to the lines coming loose from each other. For this reason, Putzmeister can also supply mounting systems that are adapted to the individual job and its requirements.



Transition pieces and reducers

Transition pieces and reducers are also available for connecting two different delivery line systems* or diameters. These are offered in three different quality grades:

- From steel: Either from extruded material that is seamless with optimised wall thickness distribution, or as ST 52 – turned down and welded with a V straight bead weld; the standard wall thickness is 6.3 mm
- Case-hardened or induction hardened: Inner hardness up to 63 Rockwell HRC, for particular stress (such as that found behind the pressure pipe)
- Reducers available from 150 mm pipe diameter to 125 mm and from 125 to 117 mm

* If you have to connect Putzmeister delivery lines with third-party systems, we also manufacture transition pieces for this on request.



Quality work from start to end

Delivery and end hoses which live up to our promises

What our pumps set in motion, the delivery and end hoses should see through to a great finish. Only once the material arrives where it is required do we see our task as being complete. For this reason, we have placed the same high demands on the development of hoses and hose accessories as we set on pumps and pipelines.

High-quality hoses

Concrete delivery and end hoses from Putzmeister are ideal for conveying concrete, but also for mortar and screeding work. They are manufactured from particularly abrasion-resistant natural rubber and include a carcass made from a four-layer steel wire insert. Yet another quality advantage is that the hose ends are stripped out, meaning the transition between the hose connection and hose is seamless. The hose connections are also hardened against wear by up to 63 Rockwell (HRC), and both of these factors reduce wear and extend the operating life of the hose.

We guarantee reliability and stability with a double safety buffer: The test pressure when new is 170 bar, while the delivery hoses are only designed and specified for a delivery pressure of 85 bar. On request, we also supply hoses with LOBA approval*.

Putzmeister concrete delivery hoses that are suitable for use with other operating pressures are also available to meet the exacting demands of special applications. Simply contact your local Putzmeister subsidiary or relevant Putzmeister dealer for more information.



Putzmeister offers concrete delivery hoses with a fabric casing too. These special concrete delivery and end hoses weigh up to 15% less than standard hoses – which machine operators can clearly feel when

handling them and which makes a noticeable difference to the payload of the machine.

* Standard for rubber qualities which correspond to the regulations of the German Landesoberbergbauamt (regional mining inspectorate).



Concrete brake with zoom nozzle

Intelligent hose accessory

Excalibur concrete brake

The Excalibur concrete brake ensures that the fresh concrete flows evenly from the end hose with liquid concrete or for small to medium delivery rates. End hose movements and the spitting out of concrete from the end hose are massively damped.

Concrete brake with zoom nozzle

The plastic concrete brake from Putzmeister prevents the concrete from dripping out of the end hose at a low pump output and high speed. A pulsating, oscillating hose could injure the personnel at the concrete placement site, or make them dirty due to spraying concrete. In contrast to the steel elbows on the end hose that are used in practice and are unreliable, the solution from Putzmeister has been tested and is safe.

Hose and end hose closure

Pneumatic hose and end hose closures from Putzmeister prevent concrete from dripping out when moving the hoses or moving the boom. This is particularly important for high-rise projects with subsequent façade construction work or when swinging out over public areas.

For the end hose shut-off valve, the delivery line on the boom tip is pneumatically compressed. It can be flexibly positioned on the hose and can be easily used to replace existing valves. With an internal diameter of 180 mm, it can be easily drawn over the end hose on the boom. The shut-off valve is connected to an existing air system on the boom or to an external pneumatic power pack or air compressor.



Excalibur concrete brake

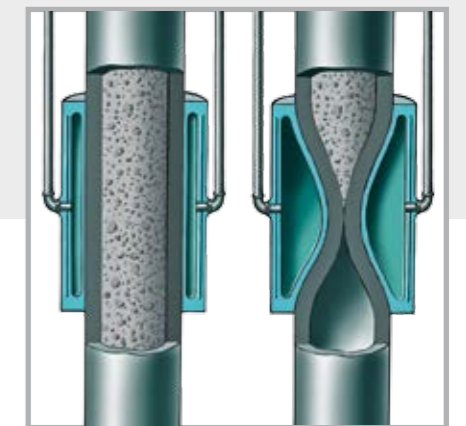

Hose and end hose closure

Cleanliness is both a duty ...

... and a choice when you use the right cleaning accessory

Pipelines must be cleaned in order to remove material residue after the concreting, and to thus counteract wear and blockages. Putzmeister offers you a wide range of user-friendly, reliable and cost-effective cleaning accessories. This ensures that the material flow is unlimited and unimpeded, and that the life of your pipework is maximised. This not only saves costs, but also valuable working time.

For complex cleaning sequences, particularly for stationary applications over great heights or considerable distances, our engineers will be happy to provide you with support. They can develop a safe cleaning process that is individually adapted to your situation.



Functional and versatile – Cleaning accessories from Putzmeister

Sponge balls and sponge pigs:

These little aids have a particularly tear-proof and tough quality of sponge rubber. When handled correctly, and then cleaned and stored correctly, they can be used 20 to 40 times without losing their cleaning power – and sponge pigs last even longer. They can be used for suction and pressure cleaning and are available for all delivery line diameters from 25 to 250 mm, and even larger diameters if requested. Sponge pigs are the slightly more expensive variant, but thanks to their greater cleaning surface they clean even better than sponge balls.

Foam cubes

Foam cubes are the affordable alternative to sponge balls. They are available in edge lengths of 200 to 250 mm for delivery line diameters of 100 to 200 mm.



Cleaning pigs

Cleaning pigs are made from rubber. They are ideal for stationary delivery lines in concrete and industrial pumps with large pipe elbows. These cleaning pigs are especially used when there is a risk of material deposits. They can be applied to or removed from the delivery line manually or with the help of a go-devil insert. For delivery line diameters of 125 mm, a highly flexible rubber pig is available which is particularly suitable for tight radius elbows.



Catch baskets

For safety reasons, catch baskets are indispensable for cleaning the line with compressed air. They prevent sponge balls and concrete residue from shooting out as a result of the explosive depressurised air exiting the line.

When cleaning with water, catch baskets have a corking effect at the end of the pipe when the cleaning aid exits the line. This also prevents large volumes of water from escaping.



Wash-out adaptors and wash-out port lids

The wash-out adaptor is used to put air or water into the line after two or three sponge balls have been introduced in the stipulated cleaning set-up. It is connected to the front or rear end of the delivery line. The wash-out port lid for the water connection can be connected to a cleaning port or to a T delivery pipe.



Measuring devices for increased checks and safety in the delivery line

With the easy-to-use measuring devices from Putzmeister, you can measure what you would otherwise only have estimated, and can be done without having to open the line: For example, finding the concrete pressure in the delivery line or the remaining wearing layer of pipeline. Thanks to this advantage when it comes to safety and checks, you can prevent damage that is caused by overstress or wear. This means that you can take countermeasures in good time in order to prevent time-consuming and costly repairs.

Pressure gauge

Pressure gauges from Putzmeister measure the concrete pressure at any required point in the delivery line. They are available for all pressure ranges, and can be connected using T-pieces which are easily integrated into the pipeline.



Mechanical wall thickness measuring device

With this cost-effective and easy-to-operate measuring device, you can measure the wall thicknesses of your pipelines. The display provides you with information about how much of the wear reserve is still available, so that the line can then be replaced in good time if required.



Digital wall thickness measuring device

With the easy-to-handle, digital ultrasound wall thickness measuring device from Putzmeister, you can determine the values measured for your wear parts reliably, quickly, simply and on-site. The measuring device has an integrated zero point adjustment for checking the standard measure. All parts that are subject to wear, such as the S transfer tube, spectacle wear plate, delivery pipe, etc., can be regularly monitored using this device and can be replaced in good time. In the case of steel, digital values measured can be read directly from the display. In the case of other materials, such as copper, aluminium, plastics, etc., the wall thicknesses can be determined with the aid of a multiplier which is detailed in the attached operating manual.



The service from Putzmeister – always there for you

Your machines and delivery lines have to be available for the planned workload – reliably and cost-effectively. One objective that we both have in common. We therefore not only focus our attention on the excellent quality of our products, but also on outstanding services for maintenance, emergencies, spare parts delivery, consultation and training.



Service

- **Service centres** in more than 150 countries worldwide
- **24-hour emergency service** in Germany
- **Tested original parts** with warranty and a 24-hour delivery service
- **Status and diagnosis data via Ergonic® Tele Service (ETS)** with transfer to separate workshop or Putzmeister service partner
- **Full-service contracts** (all maintenance work and spare parts are calculated per metre that is pumped)
- **Service packages** for maintenance and inspection
- **Manufacturer's inspection according to the requirements of the VDMA (German Engineering Federation)**
- **Individual training courses and seminars** in the Putzmeister Academy
- **Expert advice and planning support** Putzmeister project engineers from the CPD (Concrete Project Division) provide assistance for planning large projects, e.g. for concreting logistics, processes and technology

If you have any further questions we are happy to answer them:

spareparts@pmw.de
(for questions on spare parts)
services@pmw.de
(for technical questions)

Delivery line systems at a glance

SK system (quick-release coupling system)

- Standard delivery line for shorter stationary lines
- For pressures of up to 85 bar in the conveyed material
- In the special version: Highly wear-resistant up to 130 bar
- Can be bent axially up to 2° after installation
- Good adaptation to uneven surfaces



SK delivery line system

ZX Zentrifix® system

- Leak-proof
- Rigid connection between the pipes
- Robust for pressures up to 250 bar
- Ideal for stationary pipeline applications
- For dynamically calculated pressures in industrial applications

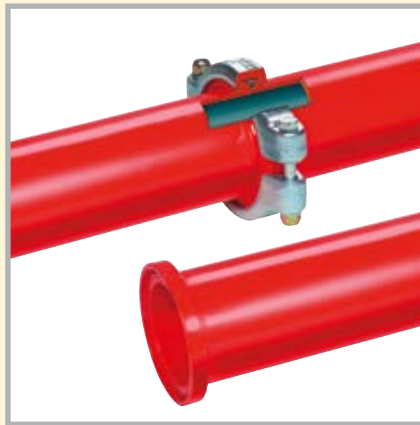

ZX Zentrifix® delivery line system

PX Ultraflex® system

- Leak-proof
- Particularly quick installation and easy to couple
- For pressures of up to 85 bar in the conveyed material
- Particularly wear-resistant because the connection is centred and rigid
- Couplings as for the SK system



PX Ultraflex® delivery line system

Putzmeister Concrete Pumps GmbH

Max-Eyth-Straße 10 · 72631 Aichtal / Germany
P.O.Box 2152 · 72629 Aichtal / Germany
Tel. +49 (7127) 599-0 · Fax +49 (7127) 599-520
pmw@pmw.de · www.putzmeister.com

