



Putzmeister



Truck-mounted concrete pumps

The intelligent power packages

Pumps that make construction dreams become reality

Height, range, dimensions, quality and economic efficiency – Convenient operation included

As a child, did you ever stand on a construction site with eyes wide open watching the construction machines in action for hours on end? Our engineers did too!

The fascination of construction is watching ideas that were jotted on a piece of paper come to fruition piece by piece. Both man and machine must perform their work 100 per cent in order for the project to be successful. It is our fascination for our work that continuously motivates us to develop extremely economical high-performance products for global construction, underground work and civil engineering projects.



No two jobs are the same

Our application reports are more like travelogues, which is no wonder because Putzmeister truck-mounted concrete pumps are highly rated all over the world:

“Railway connection for Tibet – Delivery of pumped concrete at a height of 5,000 m”. The exertions are great for both man and machine but the Putzmeister truck-mounted concrete pump easily keeps the pace at a height of 5,000 m.

“Expansion of Frankfurt airport: Large-scale concreting of the rolling bridges for the Northwest landing runway”. The West Bridge was concreted efficiently and on schedule as a result of exact planning of the locations of the four large boom pumps by Putzmeister. The superstructure was tackled using one M63, one M62 and two M58 machines.

“Oil refinery in Jamnagar: Four truck-mounted concrete pumps in action”. The first New Generation Putzmeister M42 is used for concreting one of the largest refineries in the world, located in West India. Together with three M36 pumps from the existing vehicle fleet, the “new” addition pumped reliably throughout the day and night.

Tasks performed on construction sites are both varied and complex – definitely a job for the specialists. Putzmeister offers all the relevant expertise and solutions.



Work with Putzmeister, because everything fits

A vision is only good
when it is feasible –
we make it happen

We cannot assume responsibility for managing your projects but can make a significant contribution to ensuring they succeed: With distributor booms between 20 and 63 m in length that cover a wide range of horizontal and vertical reaches encountered in all customary truck-mounted concrete pump applications. With folding types flexibly adapted to the application and vehicles that are so compact that the route to the site of concrete placement never seems like an obstacle course. With low-wearing materials and a machined finish that can withstand even prolonged periods of intensive operation.



You will also appreciate the speed with which the machine is set up and dismantled, along with the silent low-wearing pumping process and simple, ergonomically advanced operation. All of this is combined with a wide selection of efficient pumps that boast an array of components adapted perfectly to one another in a re-fined geometry.

The bottom line: Investing in high-performance products from Putzmeister always pays dividends. Twinned with a high resale value, the total sum of the purchase price together with lower energy, maintenance and service costs over the long life of the machine, make the investment more than worthwhile.

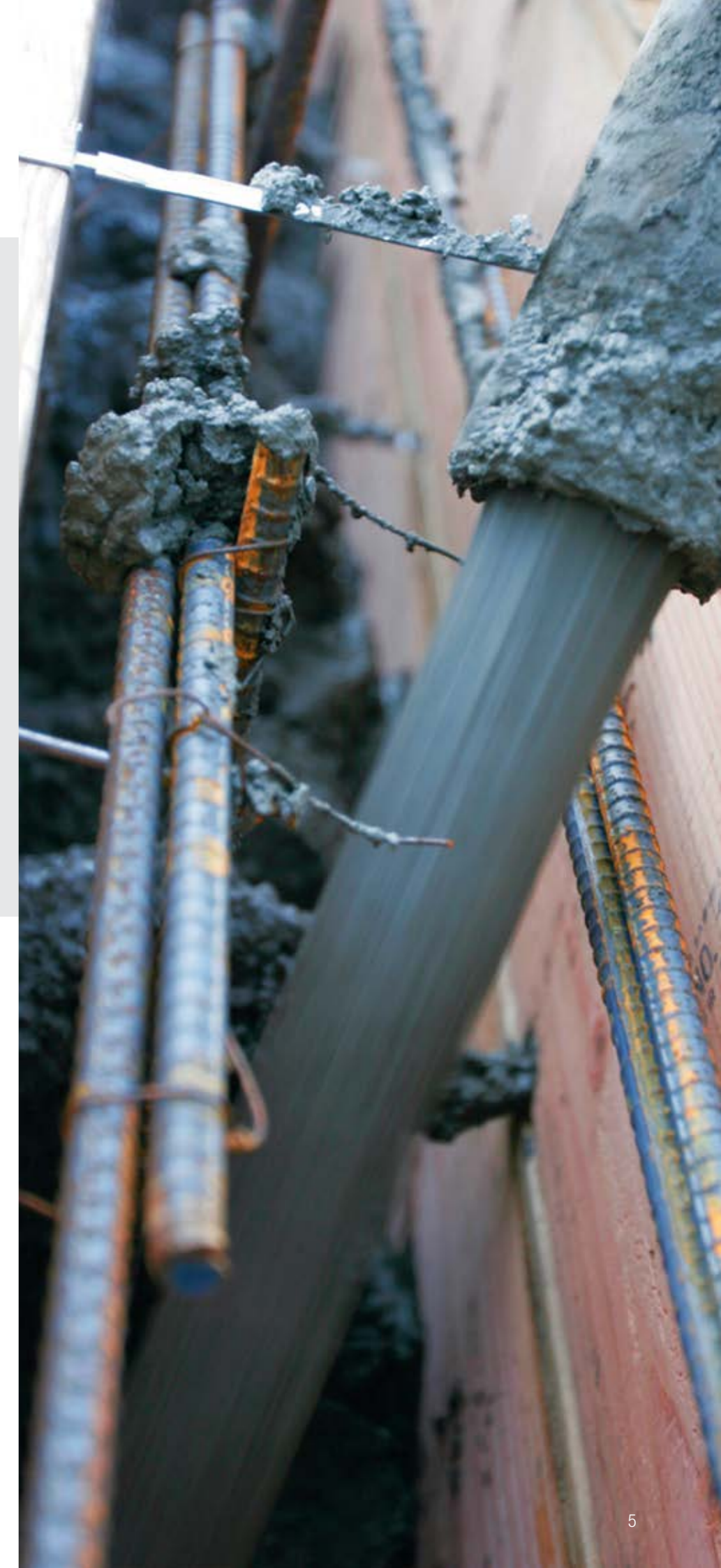

Putzmeister through and through

Quality that you can rely on, day after day

Do you have high expectations of your machinery? We do too because it is our job to develop and produce construction machinery that delivers an outstanding performance every day on the construction site, satisfies all technical requirements and leaves nothing to be desired in terms of user-friendliness. We could sit back with a sense of self-satisfaction, but we don't because we want to design lighter, stronger distributor booms to allow you to utilise your weight reserves for equipment and accesso-

ries. Also, we do not like to take wear for granted. Our restlessness has led to the continuous further development of our products as well as the use of innovative 3D-CAD programs, FE analyses, welding robots for creating perfect welded seams and feedback from our customers to assist in the implementation process.

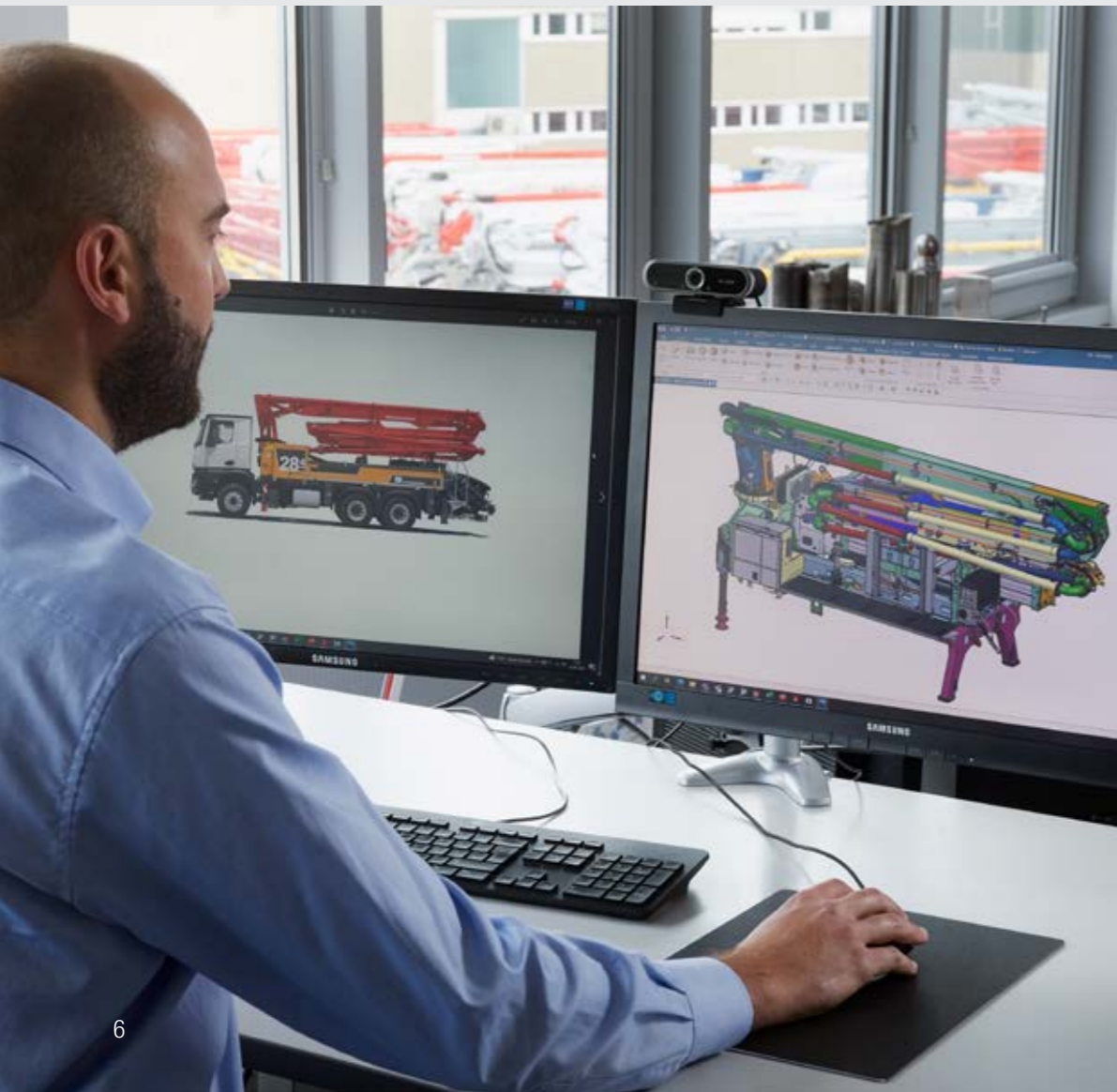

Harder than reality

The most important thing of all is that innovations are proven in practice. Up to now, our products have already been through the mill. Extensive tests make sure that on the construction site, there is one thing you can rely on without a shadow of a doubt: Your Putzmeister machine.

- **Lifetime simulations** for placing booms
- **Wear tests** for delivery lines, spectacle wear plates, etc.
- **Pulse tests and burst pressure tests** for delivery and hydraulic hoses
- **Climate, temperature and spray water tests** for all machines and their components
- **Comprehensive field tests** for the entire machine



Outstanding placing booms

Anyone who has a choice of options can select the best one

Not only can you choose between different vertical reaches, but also between a selection of booms with 4, 5 or 6 arms in a Z-fold system, roll Z-fold system or Z-roll fold system to increase flexibility and versatility in practical applications.

Streamlined kinematics on all models are designed to make optimal use of the space available in the working area.

Distributor booms from Putzmeister are manufactured exclusively from components with a high resistance to wear and parts that are close to maintenance free. Special components have been omitted in favour of standard components. Good accessibility makes service and repair work quicker, easier and more efficient.



Benefits at a glance

- Choice between different reaches and booms with 4, 5 or 6 arms in Z fold system, roll-Z fold system or Z-roll fold system for greater **flexibility and versatility in all applications**
- **Virtually no dead zones** on either folding type
- **Distributor booms manufactured from low-wear, low-maintenance components**
- **Good accessibility** to all components
- Boom control with **direct response characteristics**
- Minimal boom vibrations ensure comfortable handling
- **EBC (Ergonic® Boom Control)** for damping vibrations, restricting the working area and one-handed control

Optimal design for you

Putzmeister booms are designed according to the main application requirements in the respective boom classes.

Not only are 4-arm booms generally sufficient in the small boom classes, but are also beneficial as they are lighter, and the truck can therefore carry a higher load in accessories. They are also easier to operate. With 4-arm booms the Z-fold and the roll Z-fold demonstrate the advantage of their great flexibility (excellent access to tight spaces, virtually no dead zones).

5- and 6-arm booms are particularly suited to where more flexibility is required. The application area of the machine increases considerably, e.g. when concreting top floors, or between the floors of buildings.

The roll Z-fold is particularly suitable here, as it is designed for 5-arm booms, but also has the advantages of the Z-fold.

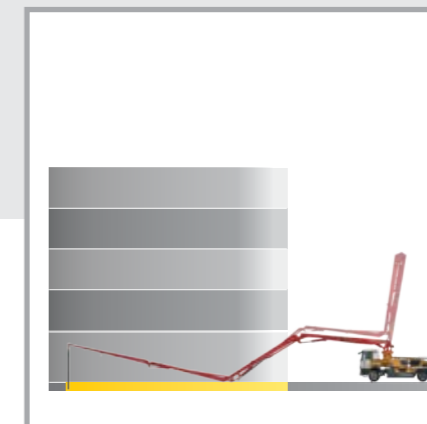
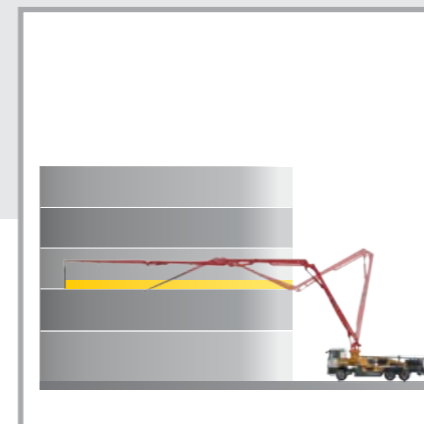
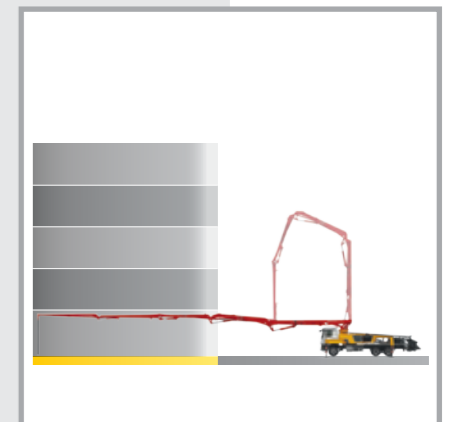
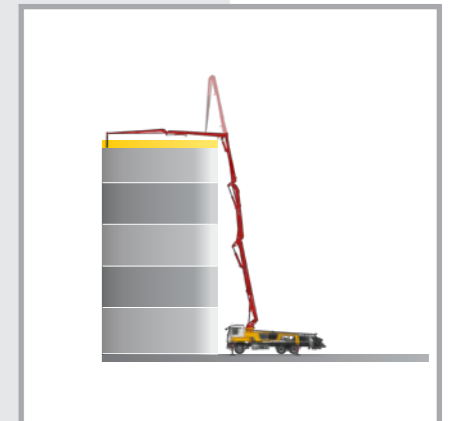

Extremely responsive operation

Even in tight spaces the direct response characteristics of the boom control and the low weight ensure accurate and convenient working progress. Minimised boom vibrations make concrete placement easier and ensure greater safety, even at high delivery

rates. The optional EBC (Ergonic® Boom Control) offers fully electronic control of the distributor booms for even greater operating comfort. One of the features of the EBC is that the boom can be operated even more smoothly in one-handed mode using

one joystick. Restricting the working area and locking the boom arms in position increases operational safety. Additional vibration damping ensures smooth guidance of the end hose and makes life easier for the machine operator.

iSC – intelligent Setup Control



Our most supportive system ever – iSC (intelligent Setup Control)

With the iSC (intelligent Setup Control), Putzmeister is raising the stability of concrete pumps to a whole new level. The successor to the proven ESC system offers a significant improvement in terms of machine reach and flexibility.

Incorporating all relevant variables directly on the construction site results in a perfect combination of maximum stability and maximum reach. In this way, iSC can perfectly support machine operators on-site in any situation.

On the safe side – now more than ever

- **Maximum versatility** Optimum support options to suit the space available on-site. Even in the most difficult of conditions.
- **Maximum reach** Perfect interaction – the reliable reach prediction allows machine operators to utilise the robust steel structure of Putzmeister machines to their fullest potential.
- **Maximum safety** 100 % safety, no small print. Guaranteed stability in any situation. The patented drop warning and the possibility of providing additional support help machine operators in difficult conditions.



Increased limits thanks to FLEX base structure

The support provided for Putzmeister concrete pumps has become more and more flexible over the past years. For the swinging support legs, it is already fully flexible and offers a variety of intermediate positions for the forward support legs. The combination of iSC and the substantially optimised steel

geometry now enables a level of flexibility not seen before. With the **new Putzmeister FLEX base structures***, supporting and setting up the machines is no easier and more flexible than ever before – and therefore incredibly straightforward for machine operators.



* Gradual introduction starting at bauma 2022, depending on the market-specific configuration.



Safe support at a glance
Clearly structured figures in real time, intuitive operation and a radio remote control make setting up on the construction site quick and easy.

Pumps that can handle almost any kind of concrete

Many mixes are special – Putzmeister pumps are too

Flowing concrete wears anything it comes into contact with. Abrasion and other damage to components such as hoppers, transfer tubes, agitators, and delivery lines are unavoidable. The extent of the wear depends on the composition of the concrete. Concrete differs significantly from country to country and even within a country.

The ingenious geometry of Putzmeister concrete pumps was designed for all standard concretes. Delivery and drive cylinders operate in perfect harmony with one another to ensure the machine performs outstandingly in combination with all other components. As a result, our pumps can deliver heavy concrete at output rates of up to 200 m³/h with ease.

Specific details such as durable delivery pistons, series standard chrome-plated delivery cylinders and the S transfer tube system designed by Putzmeister ensure that all machines are able to withstand long periods of intensive use.

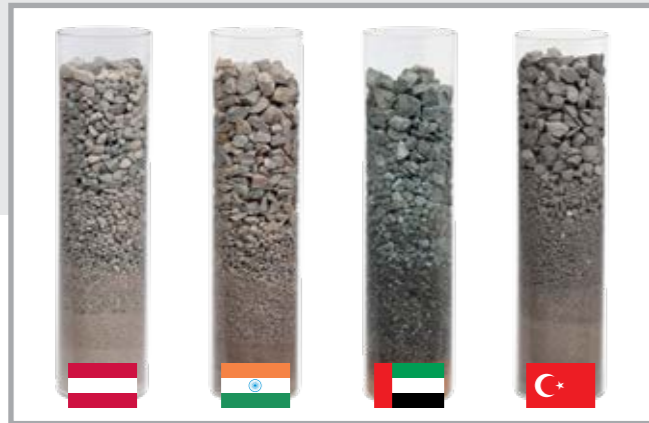

Examples of concrete mixes from 4 countries (from left to right): rounded gravel from Austria, broken stones from India and Dubai, the sample of aggregate from Turkey on the far right was particularly sharp and hard. The grading curves of the aggregate range from fine (bottom) to coarse (top).

The S transfer tube – the wear-resistant transfer tube that ensures the coarsest mixes are delivered in an even flow

The S transfer tube is used for good reason in truck-mounted concrete pumps from Putzmeister. The impressive tube is highly versatile in delivering difficult concrete mixes such as hydro-concrete or mixes consisting of broken quartz, granite or basalt.

In order to handle such wear-intensive materials, particular emphasis was placed on a long service life. The S transfer tube has therefore been reinforced with additional welding, the service intervals are considerably longer and the availability of the machine is greater than other systems. One other advantage is the quick, smooth switchover process, which ensures a virtually continuous flow of concrete and minimises vibrations on the machine.



Advantages of the S transfer tube:

- **Operates quickly and quietly** even on viscous, wear-intensive and coarse-grained mixes
- **Long service life and service intervals** ensure a high degree of machine availability
- **Extended machine lifetime** due to welded wear layer
- **Simple replacement** of the gate valve whenever required
- **Optimised switch over process and fewer vibrations on the machine** and boom thanks to the computer-controlled hydraulic system (EPS)

Technical data – Pumps

Type	Output m ³ /h	Pressure bar	Stroke mm	Cylinder Ø mm	Strokes/min
09 H	90	78	1 400	230	26
11 H	110	78	1 400	230	32
11 H LS	110	85	1 400	250	27
15 i LS**	150	85	2 100	250	24
16 H	160/108*	85/130*	2 100	230	31/21*
16 H LS	160	85	2 100	250	26
17 i LS	170	85	2 100	250	27
19 i LS	190	85	2 100	250	30
Saniermobil 1 409 S	90/56*	70/112*	1 400	230	26/16*
Moli 2 110 HP	106/69*	150/220*	2 100	200	26/18*
Moli 2 116 H	160/108*	85/130*	2 100	230	31/21*
RoLine 06	58	25	–	–	35

Note: Large cylinder volumes have already proven successful as they reduce the change-over frequency, wear and increase smooth running. The boom operates more smoothly owing to the smaller number of change-overs.

All data theoretical maximum values

* rod side / piston side – Max. delivery rates and max. delivery pressures cannot be operated at the same time. Standard boom pipework: pressure up to max. 85 bar

** From 30 m only available with iONTRON



Efficient drive for economical operation

Free-flow hydraulics – save fuel at full power in a closed system

Today concrete pumps are predominantly operated by hydraulic systems. Putzmeister places its trust in the benefits of free-flow hydraulics because the most important performance factors are the concrete pressure, low-loss oil delivery and costs.

When large quantities of concrete are pumped, large quantities of oil also flow inside the hydraulic system. More power is transferred inside a closed free-flow hydraulic circuit because the oil is conveyed from the pump to the drive cylinders with minimal losses. The adapted hydraulic system ensures extremely powerful interaction be-

tween components because the oil ratio is perfect. Compared to an open circuit, this ingenious drive technology requires significantly less oil and does not generate as much heat. The system is also economical to operate because it achieves a high degree of energy efficiency and is easy to service.

- 1 Main pump
- 2 Feed pump
- 3 Drive cylinders

- High pressure
- Low pressure
- Swing oil
- Feed pump on suction side

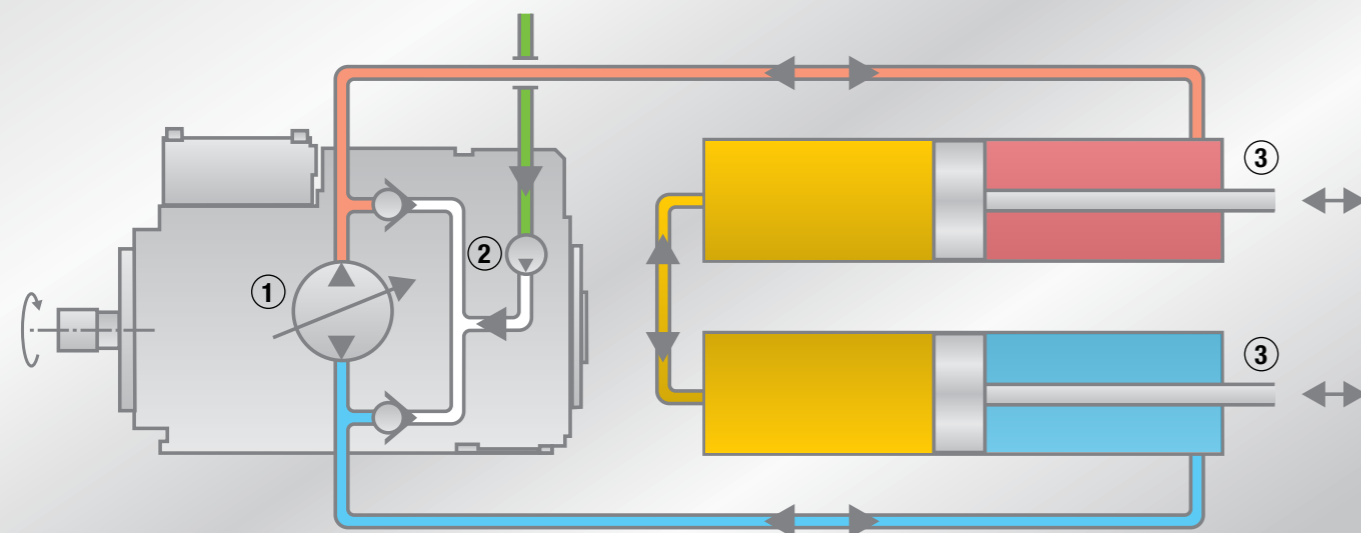

Benefits of free-flow hydraulics at a glance

- **More power** and less energy lost
- **High efficiency**
- **While valves interrupt the oil flow in other systems, the intelligent control directs the oil into the drive cylinders without significant losses**
- **Expensive control blocks are not required** which avoids the oil heating up and makes servicing easier
- **Powerful, convenient operation** due to good ratio

Work more conveniently and economically with the SN control and push over feature

Putzmeister concrete pumps are renowned for their smooth filling characteristics. Primarily responsible are the so-called SN (Surge Neutraliser) control and push over feature, which optimise switchover procedures and avoid wear-intensive peaks in pressure, extending the service life of the drive, delivery line and mounting.

The output flow rate is only interrupted momentarily because the start of the piston stroke and filling tube changeover process interact perfectly. An infinitely variable regulator meters the concrete quantity sensitively with maximum pressure even at the slowest delivery rates. One significant side effect is that the end hose is guided more smoothly and easily.

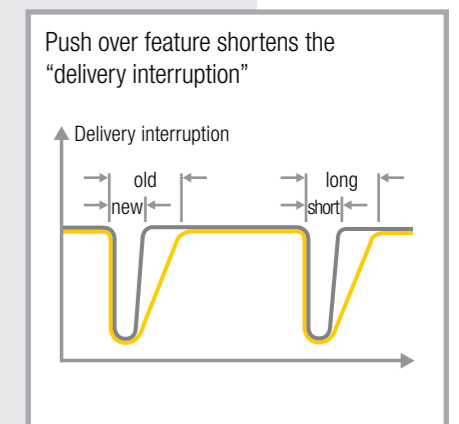
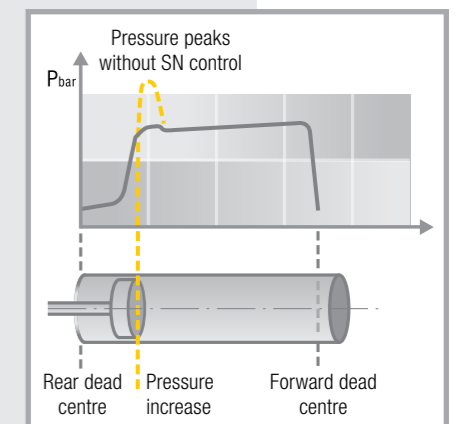

Ergonic® 3 – precise, intuitive and reliable!

Dedication in every respect

Ergonic® inside means that the machines are quickly ready for use and they work with high power, fuel efficiency and low wear. And most importantly for machine operators: **Work becomes easy!**

ergonic®
inside 3



Pumping made smart
If our concrete pumps form the heart of Putzmeister machines, then the Ergonic® 3 system is the brain.



The new Ergonic® 3 – clear, fast and safe

- Continuous operating concept for all Putzmeister products with the same functions and displays – whether on the radio remote control or the Ergonic Graphic Display (EGD).
- Intuitive work and quick reactions thanks to a clear menu structure and intuitively arranged functions.
- Full overview of machine status on the radio remote control and EGD (incl. valves, sensors, LEDs on fuses).
- Detailed fault management: Faults are easy to detect and rectify – even without a Putzmeister technician.
- Multi-level emergency operation keeps the machine running even in the toughest conditions and in virtually every case.

Keeping an overview – in every situation

- The “static” menu bar guides users through the menu – with no chance of “getting lost”.
- Neatly and intuitively arranged functions.
- Simple menu structure with a maximum of two submenu levels.
- Main menu with all standard functions and additional details in submenus.

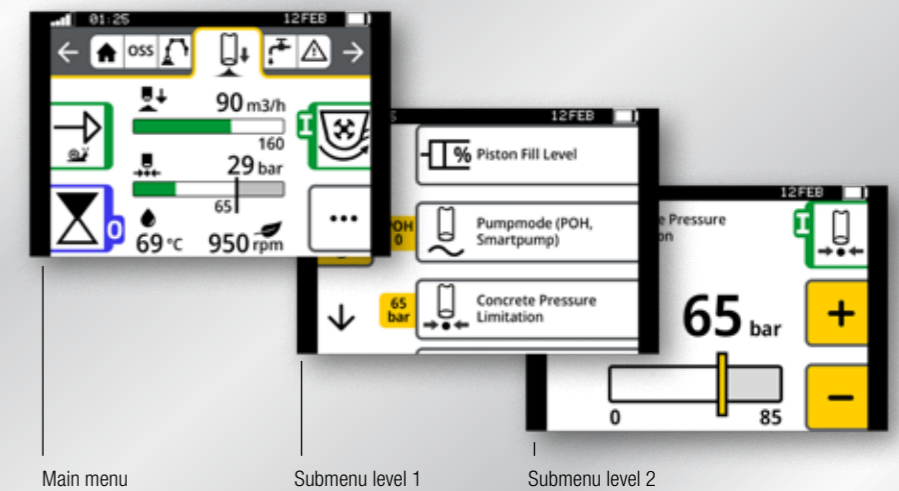

The additional screen on the control cabinet uses the same concept and offers a variety of information, settings and options.

Consistent concept on all “switching centres”

- The menu structure is nearly identical on the remote control and the graphic display.
- Hardware and software are perfectly matched at all operating positions.
- The same intuitive operation on all Putzmeister products – without requiring a lot of training.

iBC – extremely precise boom movements



Unrivalled convenience

The patented iBC control system makes it easy for machine operators to control the boom with the joystick using just one hand. As a result, the end hose can be moved forwards, backwards or diagonally at the preselected height with a great deal of precision.



Unrivalled precision

The latest Putzmeister development is a big hit with machine operators: iBC made it possible to improve the boom's response characteristics and precision by another 80 %.

The advanced boom damping delivers a stable, steady arm assembly at high delivery rates.



Unrivalled ease of folding

Folding and unfolding the arm assembly has never been this easy. With iBC, the boom movements are optimised for the exact machine model. Standard movements are carried out quickly and easily.



Intelligent boom control – an unrivalled dimension of convenience and precision

The performance level of a truck-mounted concrete pump is evident in how precisely, quickly and safely the boom can be moved and positioned. As a pioneer in intelligent boom control systems, Putzmeister has already demonstrated how user-friendly a concrete pump can be with the EBC.

With **iBC (intelligent Boom Control)**, this system is now improved again – setting new standards for convenience and precision.



Additional safety for complex obstacles

A maximum and minimum value can be specified for every hinge position. The intelligent teach-in function transfers the limits for the uppermost hinge to all others, for example to prevent collisions with the ceiling in low buildings.

Ingenious right down to the last detail

Virtually indispensable – The comprehensive Putzmeister equipment

Components that pay dividends every time they are used

The quality of installed components such as delivery lines and other wear parts is tailored to your requirements. You have the choice of selecting between different quality categories, depending on the load from different materials, special compression ratios or local conditions, for example. All have one thing in common: They are very economical in terms of service life and purchase costs.

Even wear of delivery lines

Putzmeister delivery lines wear evenly from the feeder container to the boom tip. This means that pipes subjected to higher loads have a more wear-resistant design than those subjected to lower loads. How do you benefit? You can usually replace the delivery line completely without affecting the useful life of individual pipes, which not only saves time and money; it also increases the availability of your truck-mounted concrete pump.

Benefits at a glance

- **Almost identical useful life of all individual components in the delivery line**
- **Components can be replaced together without loss**
- **Delivery lines available in 3 variants that cover individual requirements:**
 - **PM 40** – single-layer pipes
 - **PM 2520** – two-layer pipes that last up to 5 times longer than the PM 40
 - **PM 2520 Proline** – two-layer pipes that last up to 10 times longer than the PM 40



Clever and practical design – a comprehensive range of equipment choices are available to you as standard or options, all in the typical Putzmeister quality.

EPS (Ergonic® Pump System)	Additional cable remote control	Hard metal wear parts
EGD (Ergonic® Graphic Display with fault management)	Cable remote control	Centralised lubrication system for hopper and arm assembly
iSC (Intelligent Setup Control) or OSS (One Side Support)	Water tank with large volumes	Lighting systems
iBC (Intelligent Boom Control)	Water tank with large volumes	Storage systems
EQV (end-hose squeeze valve)	Ergonomic working platform	High-pressure and flushing water pump
Radio remote control with display	Diesel tank in one rear support leg	
Connections for emergency supply	Chromium-plated delivery cylinders	

And much more...



The pneumatically operated end hose shut-off valve (EQV) interrupts the flow of concrete and prevents dripping.



Economical compressor operating at 455 l/min and generating 12 bar pressure – with compact dimensions, mounted behind the lateral underrun ride guard.



The ergonomic working platform with non-slip surface offers plenty of space for the machine operator.

Quality for every load requirement

The concrete pump is exposed to different levels of stress depending on the type of concrete mix used, which is why Putzmeister wear parts are manufactured with different quality classes:

- **DURO 22:** versatile and inexpensive but with sufficient service life for nearly all concrete pump applications
- **Carbide:** high hardness values, 2 to 4 times longer service life compared to the deposition welded version
- **Heavy-duty casting:** not as resistant to wear as the DURO 22, however the absence of cracks is a distinct advantage as it provides greater resistance to shear wear and is therefore suitable for thin concrete and pumping to elevated locations



Folding steps in order to prevent damage when filling with two truck mixers.



Spot lights to illuminate the four support legs make it quicker and safer to set up the machine in the dark.



The mobile bypass filter extends service life and means oil changes are less frequent.

Ideal dimensions for indoor and outdoor activities – The 20 and 30 m class



Contortionists with minimal space requirements – flexible, manoeuvrable and an essential addition to any project

Truck-mounted concrete pumps from the 20 to 30 m class can weave effortlessly through the heaviest inner city traffic and along narrow street gaps on 2 or 3 axles. Bridges and underpasses do not represent a hazard because the trucks are extremely low in height and can pass under almost any road structure. They also offer a host of advantages such as sufficient weight reserves to accommodate comprehensive accessories without exceeding the maximum permitted weight.



Machines from this class utilise their full potential on the construction site: flexible booms with 4 or 5 arms that can operate precisely inside low buildings, tunnels or under bridges, with an unfolding height of below 4 m. Ideal for extremely efficient operation on small and medium construction sites.

* no EEA, no CE marking
** EEA, CE marking

Note: the illustrations may differ from series models. Subject to technical modifications and errors.

M20

4-arm Z-roll fold system

Vertical reach 19.5 m
Horizontal reach 16.1 m
Depth of reach 11.1 m
Unfolding height 3.9 m

Support width

Front 3.4 m
Rear 2.6 m



M31

5-arm MRZ fold system

Vertical reach 30.5 m
Horizontal reach 26.3 m
Depth of reach 20.4 m
Unfolding height 5.7 m

Support width

	front	rear
Standard	5.5 m	7.0 m
OSS*	4.0 m	5.8 m
iSC**	2.6 – 5.5 m	2.6 – 7.0 m

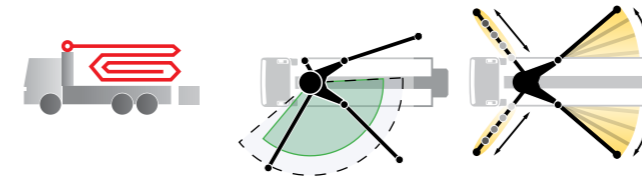

M24

4-arm Z-roll fold system

Vertical reach 24.1 m
Horizontal reach 19.7 m
Depth of reach 13.4 m
Unfolding height 4.7 m

Support width

	front	rear
Standard	4.5 m	2.6 m
OSS*	3.5 m	2.6 m
iSC**	2.6 – 4.5 m	2.6 m

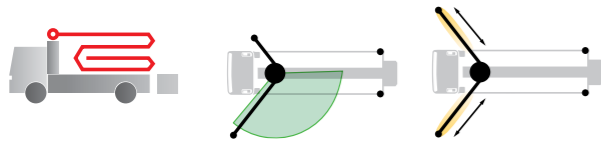

M36

4-arm Z fold system

Vertical reach 35.6 m
Horizontal reach 31.4 m
Depth of reach 23.1 m
Unfolding height 8.5 m

Support width

	front	rear
Standard	5.5 m	7.0 m
OSS*	4.0 m	5.8 m
iSC**	2.6 – 5.5 m	2.6 – 7.0 m

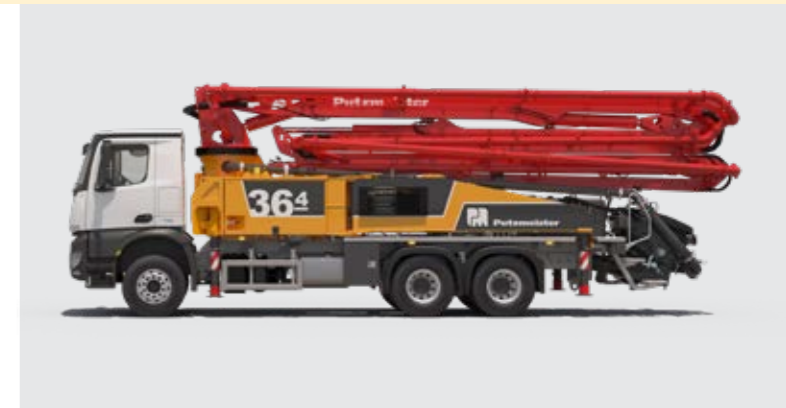
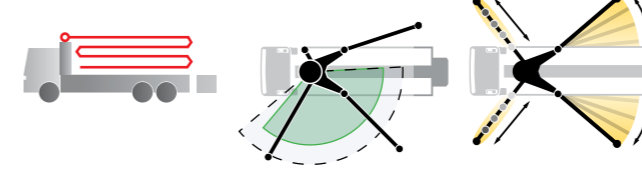

M28

4-arm Z fold system

Vertical reach 27.7 m
Horizontal reach 23.4 m
Depth of reach 16.0 m
Unfolding height 6.3 m

Support width

	front	rear
Standard	5.2 m	2.6 m
OSS*	3.9 m	2.6 m
iSC**	2.6 – 5.2 m	2.6 m

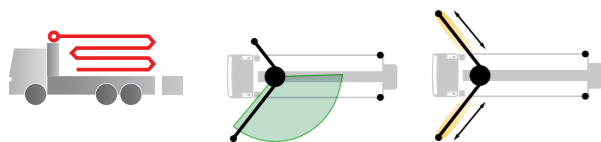

M38

5-arm roll Z-folding

Vertical reach 37.5 m
Horizontal reach 32.8 m
Depth of reach 25.3 m
Unfolding height 7.4 m

Support width

	front	rear
Standard	6.0 m	8.1 m
OSS*	4.3 m	6.3 m
iSC**	2.6 – 6.0 m	2.6 – 8.1 m

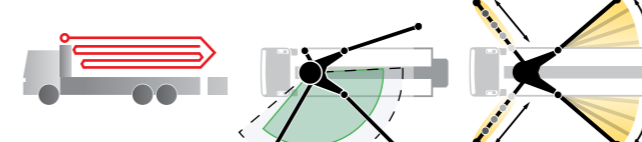

Long reach, compact folding

The 40 and 50 m class



Medium class distributor booms with premium application possibilities

The perfect ratio of small support dimensions and a long reach make the 40 m class an all-rounder among truck-mounted concrete pumps. They can frequently be found on medium and large construction and civil engineering sites, often in a restricted space. Medium class machines are both powerful and flexible. Ingenious folding systems, predominantly the Z-roll version can fully extend to maximum reach and allow safe, smooth working progress with high-performance pumps in buildings with multiple storeys for example. Forces are transferred directly to the 4 support legs, which has a positive effect on pumping operations as well as the service life of the vehicle.

* no EEA, no CE marking
** EEA, CE marking

Note: the illustrations may differ from series models.
Subject to technical modifications and errors.

M51

5-arm roll Z-folding

Vertical reach	50.1 m
Horizontal reach	44.9 m
Depth of reach	34.9 m
Unfolding height	10.2 m

Support width

	front	rear
Standard	9.3 m	10.6 m
OSS*	5.9 m	7.6 m



M53

6-arm roll Z-folding

Vertical reach	52.3 m
Horizontal reach	47.1 m
Depth of reach	37.4 m
Unfolding height	15.4 m

Support width

	front	rear
Standard	9.0 m	12.4 m
OSS*	5.9 m	8.3 m
iSC**	2.6 – 9.0 m	2.6 – 12.4 m

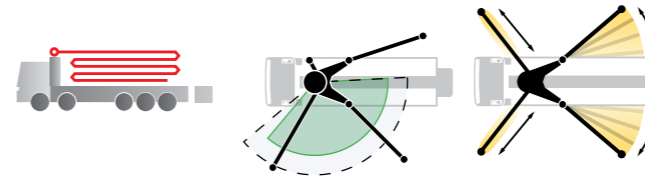

M42

5-arm roll Z-folding

Vertical reach	41.6 m
Horizontal reach	37.3 m
Depth of reach	31.0 m
Unfolding height	8.6 m

Support width

	front	rear
Standard	7.5 m	8.3 m
OSS*	5.0 m	6.4 m
iSC**	2.6 – 7.5 m	2.6 – 8.3 m

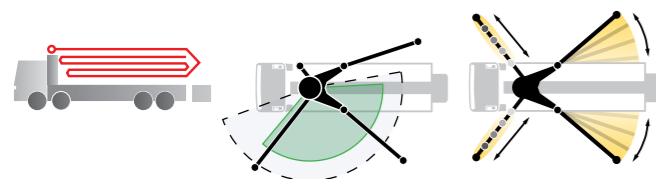

M54

5-arm roll Z-folding

Vertical reach	53.6 m
Horizontal reach	48.4 m
Depth of reach	39.8 m
Unfolding height	15.4 m

Support width

	front	rear
Standard	9.0 m	12.4 m
OSS*	5.9 m	8.3 m
iSC**	2.6 – 9.0 m	2.6 – 12.4 m

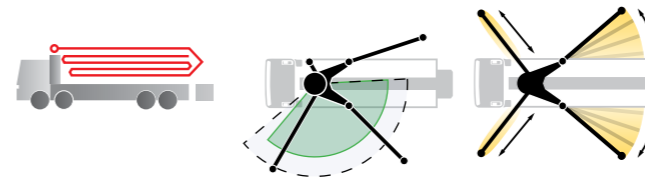

M46/M47

5-arm roll Z-folding

Vertical reach	45.5 m
Horizontal reach	40.5 m
Depth of reach	32.8 m
Unfolding height	11.1 m

Support width

	front	rear
Standard	8.4 m	9.3 m
OSS*	5.6 m	6.9 m
iSC**	2.6 – 8.4 m	2.6 – 9.3 m

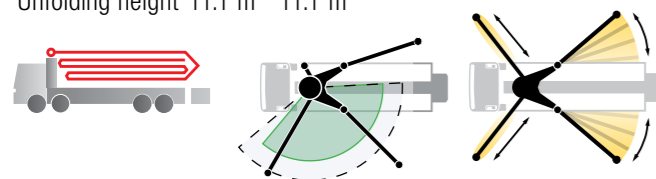

M56

5-arm roll Z-folding

Vertical reach	55.1 m
Horizontal reach	49.9 m
Depth of reach	40.3 m
Unfolding height	15.6 m

Support width

	front	rear
Standard	9.0 m	12.4 m
OSS*	5.9 m	8.3 m
iSC**	2.6 – 9.0 m	2.6 – 12.4 m

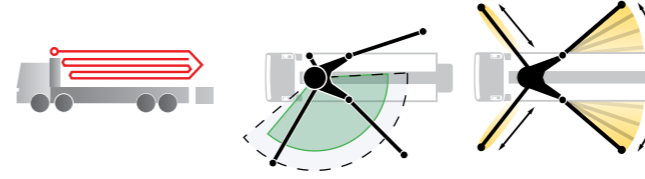

Option of 4 or 5-axle chassis, depending on approval regulations and equipment

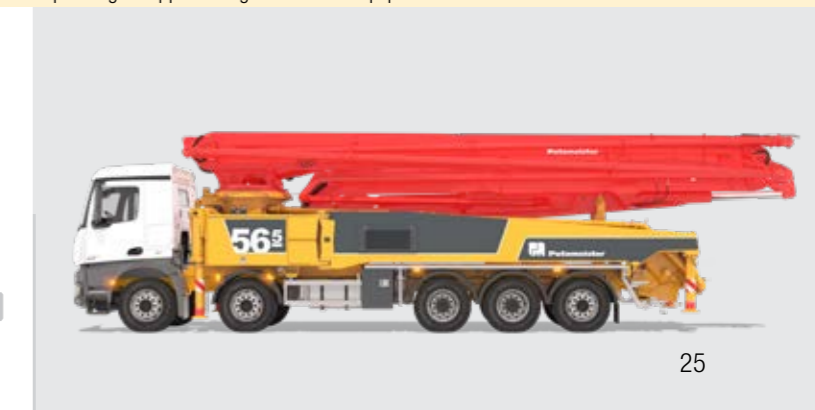

Keeping the competition at arm's length

The 60 m class

Gentle giants – vertical reach of almost 63 m

They specialise in large construction sites, but that does not mean that they take up a lot of space. The series standard assistance system (OSS) or safety system (ESC) for single-sided support enables the installation of large booms in

locations with restricted space. The extremely flexible machines have 5 or 6 arms and fully utilise their long reach right to the top storey of buildings.

30 years of know-how and experience in the design and manufacture of construction machinery were applied to develop these models.



M60

6-arm roll Z-folding

Vertical reach	59.2 m [#]
Horizontal reach	54.2 m [#]
Depth of reach	44.1 m
Unfolding height	13.0 m

Support width

	front	rear
Standard	12.1 m	13.2 m
OSS*	5.9 m	7.8 m

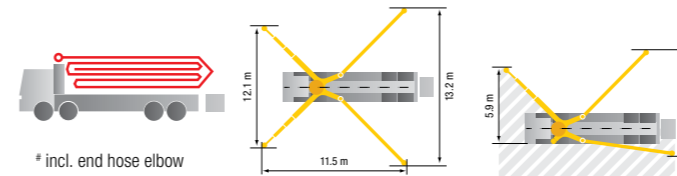

* incl. end hose elbow



M62

6-arm roll Z-folding

Vertical reach	60.2/61.1 m [#]
Horizontal reach	56.1/57.1 m [#]
Depth of reach	44.3 m
Unfolding height	23.0 m

Support width

	front	rear
Standard	12.4 m	12.2 m
OSS*	7.5 m	8.3 m
iSC**	2.6 – 12.4 m	2.6 – 12.2 m

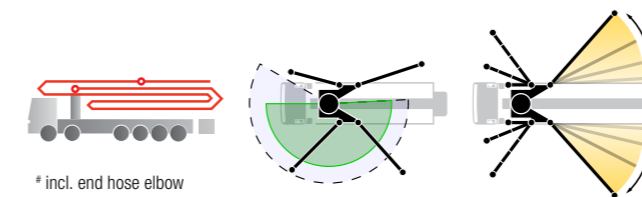

* incl. end hose elbow

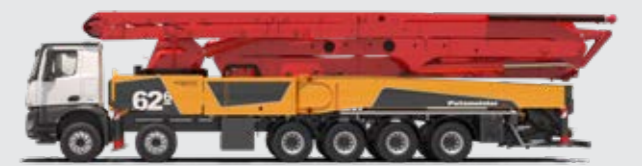

M63

5-arm roll Z-folding

Vertical reach	62.1 m
Horizontal reach	58.1 m
Depth of reach	46.3 m
Unfolding height	23.0 m

Support width

	front	rear
Standard	12.4 m	12.2 m
OSS*	7.5 m	8.3 m
iSC**	2.6 – 12.4 m	2.6 – 12.2 m

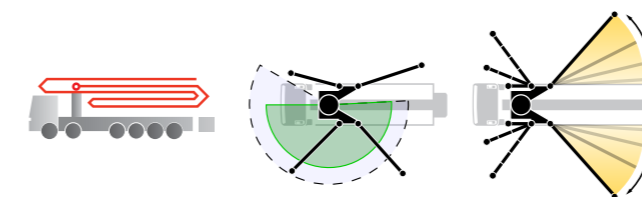

* no EEA, no CE marking
** EEA, CE marking

Note: the illustrations may differ from series models. Subject to technical modifications and errors.

When things get tight

Intelligent design, professional implementation – for economical operation in special projects

Mobile concrete pumps never hang around for very long. These truck-mounted concrete pumps offer an economical solution specially designed for urban areas, narrow, complex construction sites and renovation work. Equipped with a powerful pump unit, they can perform several jobs per day, carry

all the equipment needed to perform concreting work and handle the most challenging concrete mixes.

These specialist machines are also extremely easy to clean, maintain and operate and are a real pleasure to work with.



BQF 06 Roline

The economical rotor pump with the right equipment for the job

Pump	BQ 06
Output	58 m ³ /h
Pressure	25 bar
Rotor Ø	65 cm



* Rod/full side – maximum delivery rate and maximum concrete pressure cannot be achieved simultaneously.

BSF 1005 Moli

Mobile pipeline concrete pump Maximum flexibility for every application

Pump	BSF 1005
Output	52* m ³ /h
Pressure	70* bar
Delivery cylinder Ø	180 mm
Delivery cylinder stroke	1000 mm



BSF 1409 S Moli

The professional refurbisher with a wide range of accessories

Pump	BSF 1409 H
Output	90/56* m ³ /h
Pressure	70/112* bar
Delivery cylinder Ø	230 mm
Delivery cylinder stroke	1400 mm



BSF 2110 HP Moli

Mobile pipeline concrete pump for high-pressure delivery

Pump	BSF 2110 HP
Output	106/69* m ³ /h
Pressure	150/220* bar
Delivery cylinder Ø	200 mm
Delivery cylinder stroke	2100 mm



BSF 2116 H Moli

Mobile pipeline concrete pump for standard applications

Pump	BSF 2116 H
Output	160/108* m ³ /h
Pressure	85/130* bar
Delivery cylinder Ø	230 mm
Delivery cylinder stroke	2100 mm



Build on Putzmeister – in service, parts, training

Everything that sets service apart

Swift assistance, meaningful advice and a reliable supply of genuine Putzmeister accessories and parts - in over 120 countries worldwide. This is what we at Putzmeister understand as first-class service.

Ideally placed to support you

We train our service technicians continuously, provide a close-knit information network and the latest equipment and consistently strive to meet our customers' needs.

Thanks to state-of-the-art technology, our employees have all the relevant technical information about your machine at their fingertips, should the need arise. Allowing us to provide you with the best possible support for emergencies, repairs or preventive maintenance.



Genuine parts for maximum availability

It goes without saying that we use only genuine Putzmeister parts in our workshops. This is the only way to guarantee consistent quality, checked for interoperability. And you can be absolutely sure that your machine meets the tough requirements with maximum performance and availability.

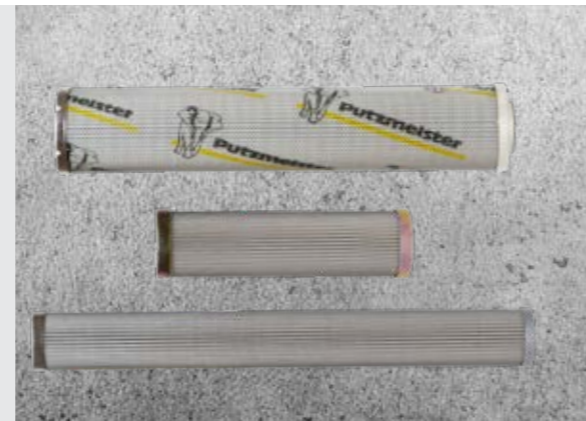

Excellent in quality and customer proximity

In case of need, you have two options: Either the service team visits you or you take your machine to one of our service workshops. The latest tools, software analysis solutions and genuine parts ensure that your machine is operable again immediately.

All Putzmeister workshops and the workshops of our international Putzmeister partners meet our high-quality standard. Especially when it comes to manufacturer's inspections and acceptance procedures in accordance with specifications.



Our range of training courses and seminars:

For concrete pump operators

- Training and development seminars on concrete pumps
- Training and development seminars on PUMI with piston and rotor pumps
- Regional/company seminars (in your region or on your premises)

For concrete pump mechanics

- Training and development seminars on concrete pump

For concrete pump machinists and mechanics

- Practical days in Aichtal
- Training: Handover and induction, on-the-job training

For workshop managers and foremen

- Overview of current developments in Putzmeister concrete pumps
- Qualification at the customer workshops for requisite maintenance work

Further information can be found at: www.pm-akademie.de



The new generations

Well-engineered down to the smallest detail – thanks to over 50 years of experience

Not just improved, but completely redesigned, resulting in the manufacture of an advanced generation of truck-mounted concrete pumps based on tried and tested principles. Countless suggestions from customers, machine operators, suppliers and Putzmeister employees have flowed into the project and combined to produce an innovation that excels in every respect. A completely redesigned model was de-vised and tested using state-of-the-art methods and scrutinised on every level – mostly with regard to the user. Comprehensive field tests more than confirmed the reliability and capability of the machine.



The most important innovations at a glance

- **Low gross weight for the respective class** including sufficient reserves for payload and operating materials
- **Silent 4 or 5-arm distributor booms** thanks to intelligent routing of the delivery line and the balanced design of the steel structure
- **Efficient operation** through consistently clever ergonomic design
- **Even better safety** through closer consideration for current standards and guidelines
- **Service-friendly** as a result of its optimised accessibility and bolted manufacturing concept
- **Lower service costs** thanks to maintenance-free components, fewer different components (e.g. only 3 standard delivery line bends) and lower volumes of operating materials (oil volume reduced by 30 %)

Note: the illustrations may differ from series models.
Further brochures: Ergonic® CT 4691



Putzmeister Concrete Pumps GmbH
Max-Eyth-Straße 10 · 72631 Aichtal / Germany
P.O.Box 2152 · 72629 Aichtal / Germany
Tel. +49 (7127) 599-0 · Fax +49 (7127) 599-520
pmw@putzmeister.com · www.putzmeister.com

 **Putzmeister**